

# Barcelona Surround - Resort F300

## SCHEME

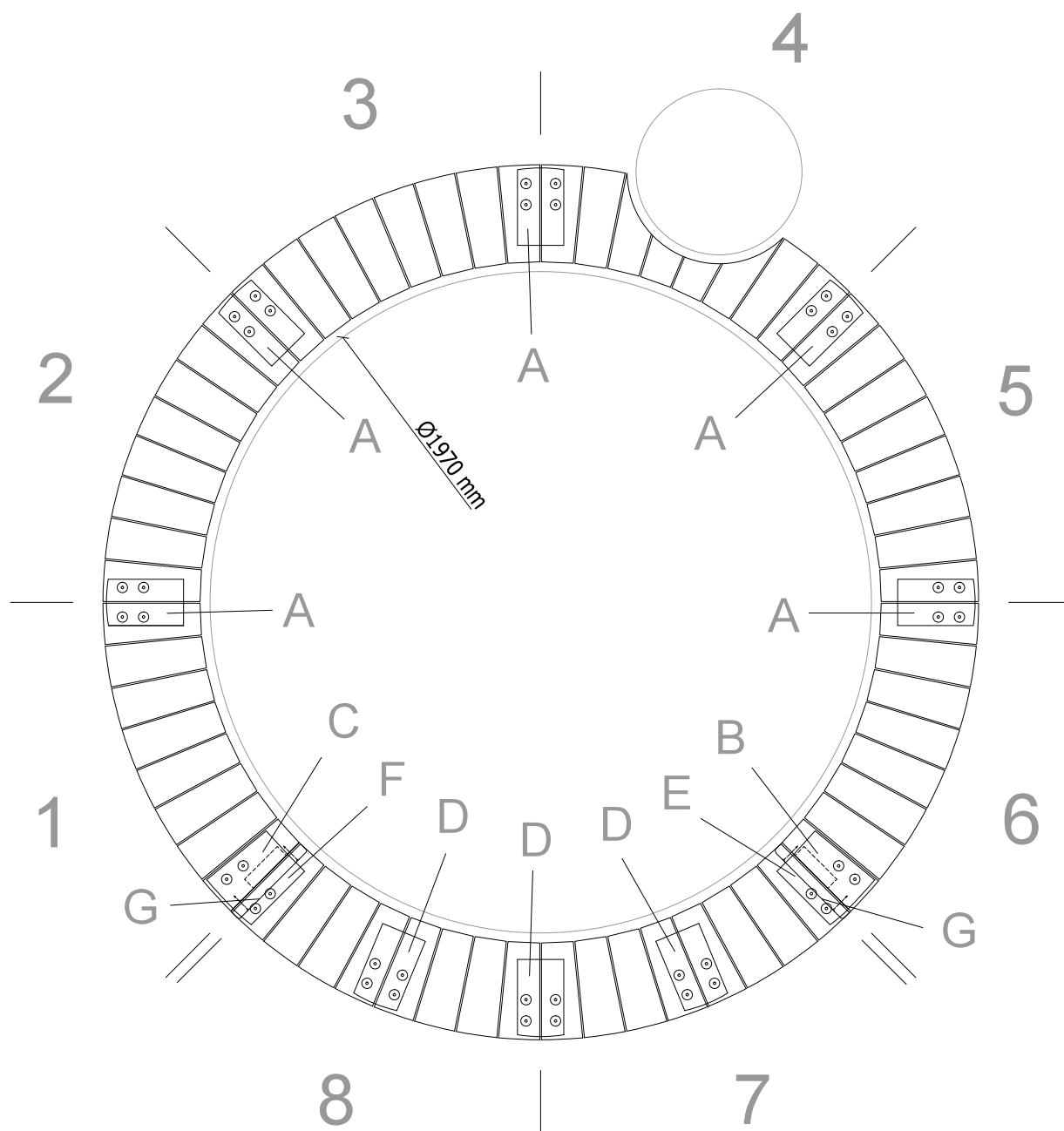

# COMPONENTS

## PANELS

1

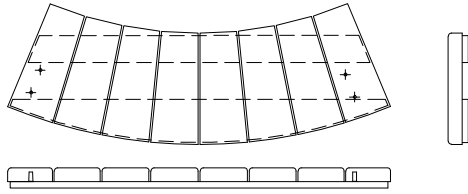

2, 3, 5

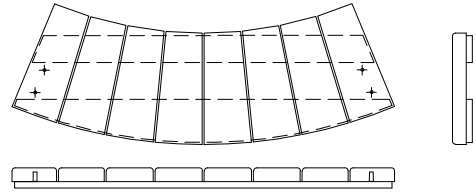

4

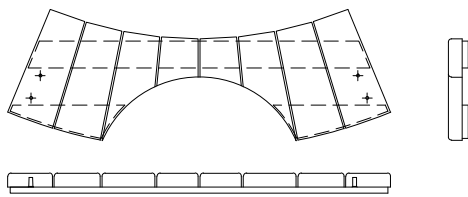

6

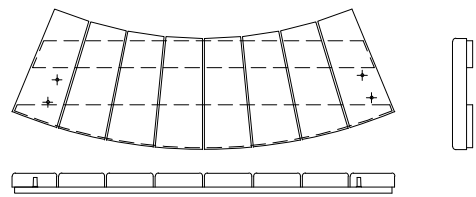

7, 8

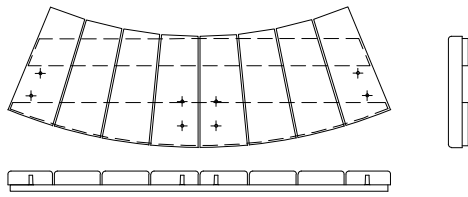

## FEET

A

5x

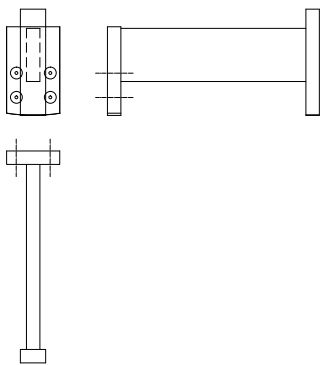

B

1x

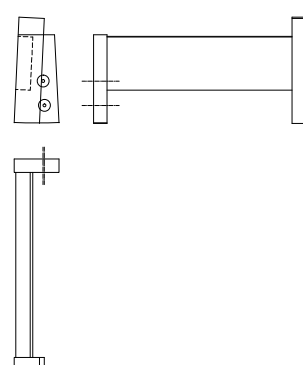

C

1x

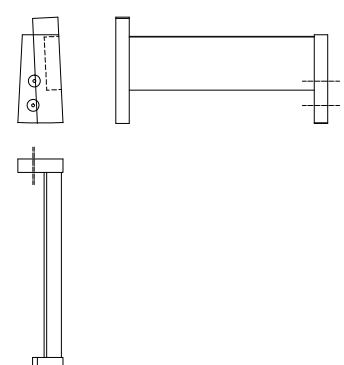

D

3x

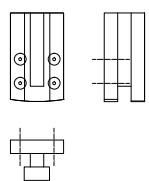

E

1x

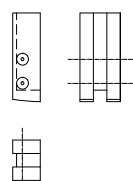

F

1x

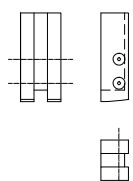

# SIDE BOARDS

**G** 2x

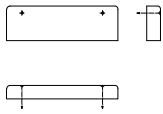

# CONSTRUCTION SUPPORT

**H** 6x

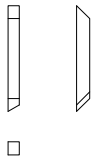

**I** 6x

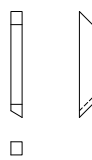

# CONSTRUCTION SCHEME

